

KENYA STANDARD

DKS 829:2021

ICS ~~##.###~~

2nd Edition

**Specification for precast concrete
channels, edgings and quadrants**



**Kenya Bureau of
Standards**

Standards for Quality life

TECHNICAL COMMITTEE REPRESENTATION

The following organizations were represented on the Technical Committee:

1. Atkins Consulting Engineers Limited.
2. Bamburi Cement Lafargeholcims
3. Bens Electronics service Ltd
4. East African Portland Cement Plc
5. Handisi systems LTD
6. Institution of Engineers of Kenya
7. Institute of Quantity Surveyors of Kenya
8. Jomo Kenyatta University of Agriculture and Technology
9. Kenya Builders & Concrete Co Ltd
10. Kenya Electricity Transmission Co. Ltd
11. Malaba Keya and Partners Consultants
12. Materials Testing and Research Division
13. Ministry of Transport, Infrastructure, Housing, Urban Development & Public Works
14. Ministry of water and sanitation
15. Nairobi Western Bypass project
16. National Housing Corporation
17. Orkidstudio_ Design and Build
18. QuestLinks Engineering Ltd
19. Questworks Limited
20. Stroutel Africa Limited
21. Technical University of Mombasa
22. Kenya Bureau of Standards — Secretariat

REVISION OF KENYA STANDARDS

In order to keep abreast of progress in industry, Kenya Standards shall be regularly reviewed. Suggestions for improvements to published standards, addressed to the Managing Director, Kenya Bureau of Standards, are welcome.

© Kenya Bureau of Standards, 2021

Copyright. Users are reminded that by virtue of Section 25 of the Copyright Act, Cap. 130 of 2001 of the Laws of Kenya, copyright subsists in all Kenya Standards and except as provided under Section 25 of this Act, no Kenya Standard produced by Kenya Bureau of Standards may be reproduced, stored in a retrieval system in any form or transmitted by any means without prior permission in writing from the Managing Director.

Specification for precast concrete channels, edgings and quadrants

Kenya Bureau of Standards, Popo Road, Off Mombasa Road,
P.O. Box 54974 - 00200, Nairobi, Kenya

 +254 020 6948000, + 254 722202137, + 254 734600471

 info@kebs.org

 @KEBS_ke

 kenya bureau of standards (kebs)

Public Review draft

Foreword

This Kenya Standard was prepared by the Concrete and Concrete Products Technical Committee under the guidance of the Standards Projects Committee and it is in accordance with the procedures of the Kenya Bureau of Standards.

This is a second edition. The revision was necessary to take into consideration the sizes that are widely specified by engineers.

This standard was adapted from the following document:

BS 7263: Part 1: 1994 Specification for precast concrete flags, kerbs channels, edgings and quadrant.

Acknowledgement is hereby made for the assistance derived from this source.

Public Review draft

Specification for precast concrete channels, edgings and quadrants

1 Scope

This Kenya Standard specifies the requirements for the following precast concrete products:

- a) Channels;
- b) Edgings;
- c) Quadrants.

These precast concrete products, referred to as a product or products in this standard, are intended for use in the construction of carriageways and footways laid in accordance with KS 1537.

notes: Annex D gives recommendations on information to be given to a manufacturer in an enquiry or order.

2 Normative references

The following referenced documents are indispensable for the application of this document. For dated references, only the edition cited applies. For undated references, the latest edition of the referenced document (including any amendments) applies.

KS EAS 18-1, Cement Part 1: Composition, specifications and conformity criteria for common cements

KS 987-1 Modular coordination - Vocabulary applicable to modular coordination.

KS 95 Specification for natural aggregates for use in concrete.

KS 2846 Mixing water for concrete — Specification for sampling, testing and assessing the suitability of water, including water recovered from processes in the concrete industry, as mixing water for concrete.

KS 1537 Code of practice for laying of precast concrete flags, kerbs, channels, edgings and quadrants.

KS 2770-1 Admixtures for concrete, mortar and grout-Part 1:Common requirements.

KS 2770-2 Admixtures for concrete, mortar and grout-Requirements Part 2:Concrete admixtures.

KS 2770-3 Admixtures for concrete, mortar and grout-Requirements-Part 3:Admixtures for masonry mortar

KS 2770-4: Admixtures for concrete, mortar and grout-Requirements-Part 4:Admixtures for grout for pre-stressing tendons

KS 2770-5 Admixtures for concrete, mortar and grout. Admixtures for sprayed concrete. Definitions, requirements, conformity, marking and labelling

EN 12878 Pigments for the colouring of building materials based on cement and/or lime. Specifications and methods of test

BS 4372 Specification for engineers' steel measuring rules

BS 4484-1 Specification for measuring instruments for constructional works. Metric graduation and figuring of instruments for linear measurement

BS 957 Specification for feeler gauges

KS ISO 7500-2:2006 Metallic materials-Calibration and verification of static uniaxial testing machines-Part 2:Tension creep testing machines-Verification of the applied force.

3 Definitions

For the purposes of this standard, the following definitions and those given in KS 987-1 shall apply:

- 3.1 nominal size**
the size of which identifies a component
- 3.2 work size**
target size of a building component specified for its manufacture
- 3.3 secondary processing**
manufacturing process carried out after basic manufacture, before or after hardening, on the whole unit or any surface

Note: Secondary processing may be used to provide flat (e.g. ground) or textured (e.g. blasted) surfaces.

- 3.4 flag**
Small slab of natural or artificial stone or precast concrete

- 3.5 tactile flag**
flag, provided with a profiled surface, used to give warning of hazards, or to enable locations to be recognized, e.g. a crossing flag.

4 Binders

Products shall be made using cement conforming to KS EAS 18-1.

5 Aggregates

Products shall be made using aggregates conforming to KS 95.

6 Water

The water shall conform to KS 2846.

7 Admixtures

Proprietary admixtures shall conform to KS 2770.

8 Pigment

Pigments supplied in powder form shall conform to EN 12878 or an equivalent Kenya Standard. Where pigments are used in the preparation of suspensions or slurries the pigments shall conform to EN 12878 or an equivalent Kenya Standard.

9 Finish

Products described as 'natural' shall contain no pigment (see Clause **D1(b)**). Where products are made with two-part mixes, the surface layer shall be not less than 25 mm thick. The surface layer shall be produced as an integral part of the product.

All arises that will be visible after laying shall be without nibs and fins.

Note: Profiled surfaces may be functional, (e.g. tactile) or decorative (e.g. riven).

10 Dimensions and tolerances

10.1 Dimensions

10.1.1 Channels and edgings

Channels and edgings shall have the sizes shown in Figures 2, and shall have a length in the range 450 mm to 915 mm. The length shall be measured along the vertical contact face between the channel. The radius of the vertical contact face of a channel shall be as given in Table 2.

Table 2. External and internal radii for channels

Dimensions					
External only		Internal and External			
1.0	2.0	3.0	4.5	6.0	7.5
		9.0	10.5	12.0	

All dimensions are in millimetres

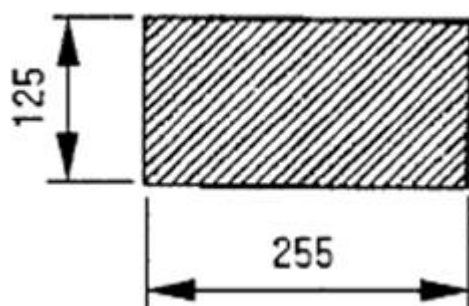

a) Channel square : Type CS1

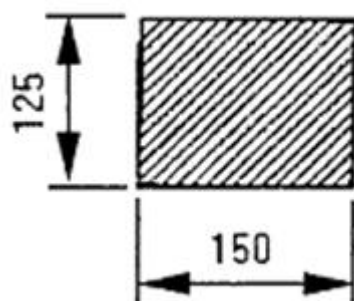

b) Channel square : Type CS2

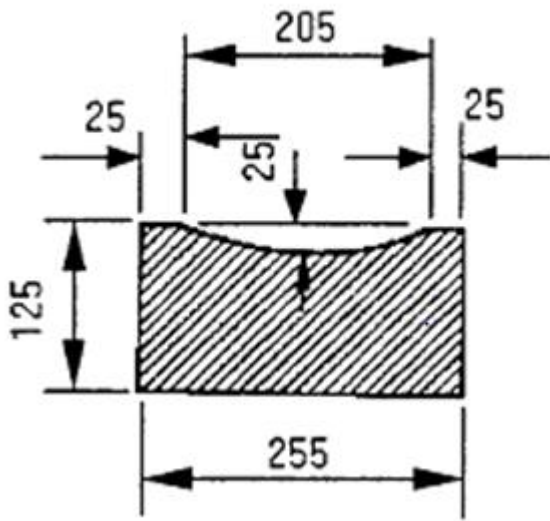

b) Channel dished : Type CD

Figure 2 — Bullnosed, splayed and half square and dished channels

All dimensions are in millimetres

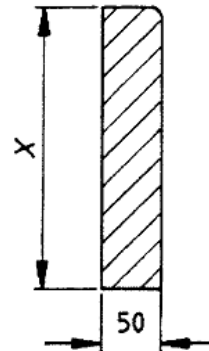
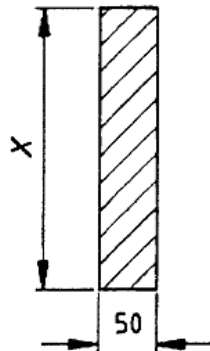
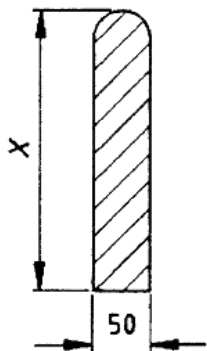

NOTE. $x = 150, 200$ or 250 mm.

a) Round top edging: Type ER

b) Flat top edging: Type EF

c) Bullnosed edging: Type EBN

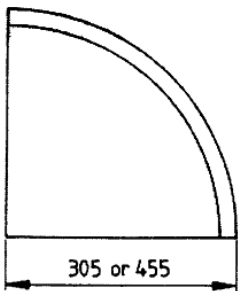

Plan

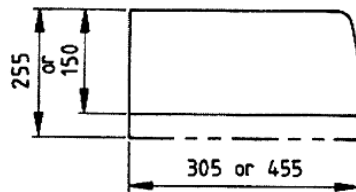

Elevation

Note. Quadrants in these sizes may have the following profile

- 1) Bullnosed type QBN
- 2) Half battered type QHB
- 3) 45° splayed type QSP

- d) Quadrants (Sizes 305 × 150 × 305 × 225 or 455 × 150 or 455 × 225)

Figure 4 - Edgings, quadrants

All angles except those resulting from splayed radiused or chamfered faces meeting as shown in Figure 4 shall be square.

10.1.2 Quadrants

Quadrants shall have the sizes shown in Figure 4(d).

10.2 Tolerances

10.2.1 Channels and Edging

The maximum dimensional deviations of any, channel and edging, measured as described in Annex A, shall be as follows:

- (a) Length, width or height: ± 3 mm;
- (b) Straightness and winding:
 - (i) Measured over, 550 mm to 850 mm: ± 2 mm;
 - (ii) Measured over 250 mm to 400 mm: ± 1 mm;
 - (iii) Squareness: 2 mm clearance.

11 Transverse strength

11.2 Channels and edgings

When sampled and tested as described in annex B, the failing loads shall be not less than the appropriate value given in Table 4

Table 4. Transverse strength of channels and edgings

depth as tested (see note 1) mm	width as tested mm	failing load (see note 2) kN
150	305	22.2
125	150	8.0
125	255	13.3
50	255	5.1
50	205	4.5
50	150	3.3
100	125	4.8

Note 1. Units are placed in the testing machine with the depth as tested being the smallest dimension.

Note 2. The failing load for channels of various lengths may be obtained by extrapolation, e.g. if the failing load for a 125 mm x 255 mm x 915 mm channel tested on a span of 750 mm is 13.3 kN, the failing load for a 550 mm kerb of the same cross-section tested on a span of x mm will be $13.3 \times (750/x)$ kN.

12 Water absorption

When tested as described in Annex C, the water absorption for channels and edgings shall not exceed the appropriate value given in Table 5.

Table 5. Maximum water absorption of channels and edgings

water absorption in % by mass	
channels and quadrants shown in Figures 2, 3 and 4	Edgings shown in Figure 4
3.0	3.6

13 Sampling and independent testing

Samples shall be taken before the products are laid and, wherever practicable, whilst they are being moved, e.g. during loading or unloading. A sample of three products shall be taken from a consignment of not more than 1,000 products. Each of the three products in the sample shall be taken from one of three approximately equal sections of the consignment to be tested.

Each product of a sample shall be uniquely marked and accompanied by a certificate from the person responsible for taking the samples, stating that sampling was carried out in accordance with this standard.

The sample shall be dispatched to the test laboratory, taking precautions to avoid damage to the products in transit.

Note: Products used for dimensional checks may subsequently be used for transverse strength or water absorption tests.

14 Marking

The following particulars relating to products made in accordance with this standard shall be clearly marked on the delivery note, invoice, manufacturer's or suppliers certificate, or brochure relating to a consignment of products:

- The name, trade mark or other means of identification of the manufacturing plant;
- The number and date of this standard;
- Type of admixture(s) used (see Clause 6);

15 Types of product

The types of precast concrete, channels, edgings and quadrants supplied in accordance with this standard shall be designated as given in Table 6.

Table 6 - Types of product

Type	Designations	Reference
Channels: Channel square Channel dished	CS CD	Figure 2(a) Figure 2(b)
Edgings: Round top edging Flat top edging Bullnosed edging	ER EF EBN	Figure 4(a) Figure 4(b) Figure 4(c)
Quadrants: Bullnosed quadrant 45° splayed quadrant Half battered quadrant	QBN QSP QHB	Figure 4(d) Figure 4(d) Figure 4(d)
Angles: Internal angle External angles	IA XA	Figure 4(e) Figure 4(f)

Annex A

Measurement of dimensions

A1. General

Remove any fins or local protrusions.

Note: It is recommended that all measurements be made using a suitable steel rule conforming to BS 4372 or BS 4484 or an equivalent Kenya Standard.

A3. Channels and edgings

A3.1 Length

Measure the length of each product to the nearest 1 mm on the face, within 25 mm of the four extreme corners of the profile. Calculate the average length to the nearest 1 mm.

A3.2 Width and height

Measure the width and height of each product to the nearest 1 mm at both ends. Measure the width at the top and bottom of parallel faces and the overall height at the face and back of the product. Calculate the average height and width to the nearest 1 mm.

A5. Determination of squareness

Place the stock of an engineer's square in contact with the moulded faces of the product. Bring the blade into contact with the side of the product. Using a feeler gauge conforming to BS 957: Part 2, check that the clearance between the square and the side of the product at points not less than 30 mm from the top and the bottom does not exceed the appropriate tolerance.

Annex B

Determination of transverse strength

B1. Testing machine

The transverse testing machine shall conform to a grade A or grade B machine when verified in accordance with KS ISO 7500 Part 1 or an equivalent Kenya Standard, and be of sufficient capacity to apply loads up to 33 kN. It shall be provided with two steel supporting rollers, each (38 ± 3) mm in diameter, or two steel bearers, each (6 ± 1) mm in width, on the supporting surfaces (see Figure B1). The spacing of the rollers or bearers shall be as given in Table B1.

Table B1- Spacing of rollers or bearers for transverse strength test

Dimensions in millimetres	
Product	Minimum spacing centre to centre of rollers or minimum clear distance between bearers
Edgings	250
Channels	750
Note: For channels from 450 mm to 800 in length, the minimum spans given in the table will have to be adjusted to give a minimum overhang of 50 mm.	

In either case, one support shall be horizontal and the other so mounted as to enable loads to be applied without inducing any torsional restraint in the specimen, e.g. by pivoting about an axis parallel to the length of the specimens. The upper member of the loading frame shall be provided with a spherical seating to ensure that the load is applied axially without inducing any torsion in the specimen, and a steel platen at least 50 mm wide and of length not less than the width of the widest specimen to be tested.

B2. Procedure

Place the specimen symmetrically on the bearers of the testing machine with its greater cross-sectional dimension horizontal and bed a 50 mm wide hardwood filled on the upper surface at midpoint of the span, using a thin layer of plaster. Allow the plaster to set before the test is carried out.

Apply the load without shock and increase it at a rate not exceeding 18.5 N/s for each 100 mm of width as tested, until the specimen fails or the capacity of the machine is reached. Record the individual failing loads in the report, except when a specimen does not fail under the upper limit of the testing machine, in which case record the failing load as 'greater than ... kN'.

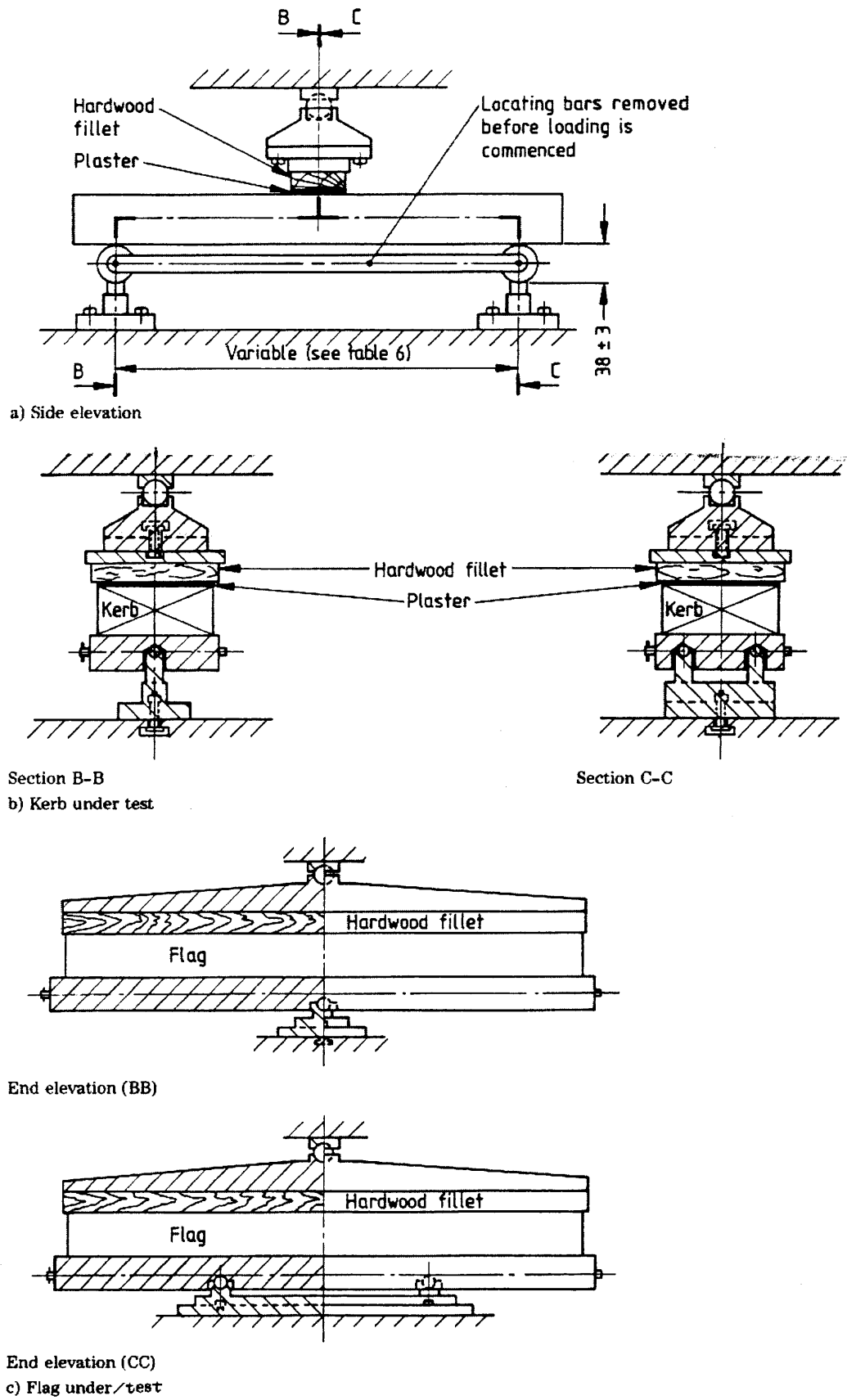

Figure B1 — arrangement of loading for transverse strength test

Annex C

Determination of water absorption

C1. Apparatus

C1.1 Balance, capable of weighing the specimens up to 5 kg with an accuracy of 0.1 per cent.

C1.2 Suitable Concrete Sawing Machine

C1.3 Ventilated drying oven

Conforming to BS 2648 or an equivalent Kenya Standard, except that the internal space may exceed 0.085 m³ in which the temperature is controlled at (105 ± 5) °C, and such that the specimens can be placed in the oven as described in C3.1.

C1.4 Tank, deep enough to immerse specimens, containing clean water maintained at a temperature of (20 ± 1) °C.

C1.5 Dry Airtight Vessel, e.g. desiccator, of sufficient size to contain the specimens to be tested.

C2. Preparation of specimens

Saw two test specimens from each of the three sample products. Cut each specimen from either end of the product. For channels take the sample from the part of the product to be exposed, which may include the profile face. The size of each specimen shall be as given in Table C1.

Table C1- Size of specimens of channels and edgings for Water absorption test

Product shown in figures 2, 3 and 4	Size of specimen
channel square type CS2 and edgings of all types	100 mm long x cross-section of product
Channel square type CS1 and channel dished type DC	100 mm long x full depth of product x 100 mm wide

C3. Procedure

C3.1 Place the six specimens in the drying oven (see C1.3) so that each one is not less than 25 mm from any heating surface and from each other. Dry the six specimens in the oven for (72 ± 2) hours. Do not place further specimens in the same oven during the drying process. Allow free access of air to all surfaces of the specimens.

C3.2 On removal from the oven, cool each specimen for (24 ± 0.5) hours in the dry airtight vessel (see C1.5). Weigh each specimen and immediately completely immerse in the tank (see C1.4) with its longitudinal axis horizontal and at a depth such that there is (25 ± 5) mm of water over the top of the specimen.

C3.3 Leave the specimens immersed in the water for (30 ± 0.5) minutes. Remove each specimen, shake it to remove the bulk of the water and dry it with a cloth as rapidly as possible until all free water is removed from the surface. Weigh each specimen.

C4. Calculation and expression of results

C4.1 Calculate the mean absorption of the two specimens from each of the three products and report the values for the three means to the nearest 0.1 per cent as the water absorptions of the products.

C4.2 Calculate the mean absorption of the two specimens from each of the three products and report the values of the three means to the nearest 0.1 per cent as the water absorptions of the products.

Annex D (informative)

Information to be given to the manufacturer in an Enquiry or order

The following particulars cover the essential details to be given to the manufacturer for an enquiry or order to be fully understood.

D1. General

Any special requirements, e.g.:

- (a) Surface finish;
- (b) Colour;
- (c) Aggregate type;
- (d) Binder type;
 - (a) Admixtures.

D3. Channels

- (a) Figure 2 and/or channel profile (type CS1, CS2 or CD of Figure 2) and overall dimensions;
- (b) Any sawn units or special instructions.

D4. Channels

(See Figure D1.)

- (a) Number of units or number of quadrants of a circle;
- (b) Profile type (channel type CS1, CS2 or CD of Figure 2);
- (c) External or internal radius of units (see Figure D1);
- (d) Radius in metres (see **10.1.2**).

D6. Edgings

- (a) Number of units;
- (b) Profile (edgings type ER, EF or EBN of Figure 4).

D7. Quadrants

- (a) Number of units;
- (b) Profile (quadrant type QBN, QHB or QSP of Figure 4);

- (c) Bed dimensions (305 mm or 455 mm);
- (d) Height dimensions (150 mm or 255 mm).

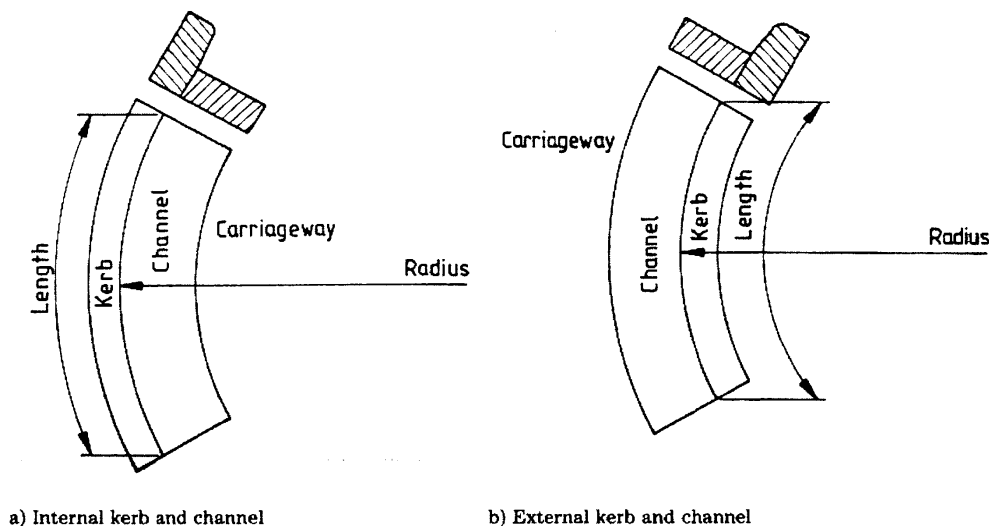

Figure. D1 — Channels

Annex E (informative)

Methods of manufacture

There are many different methods for manufacturing the type of products covered by this standard. The most common methods are as follows:

- (a) *Semi-dry process* — A moist mix is compacted by pressure or by simultaneous vibration and pressure or by taping. The resulting products are demoulded immediately;
- (b) *Wet press process* — Starting with a very wet mix, excess water is removed under a pressure of at least 5 MPa over the entire surface. The products are demoulded immediately;
- (c) *Wet cast process* — A mix with water : cement ratio in the range 0.40 to 0.55 is placed into moulds and compacted. The products are normally demoulded on the following day. This wet cast process is not used for flags covered by this standard.

This Standard defines and specifies requirements and conformity for admixtures specifically intended for use in sprayed concrete.

The types of admixtures covered are:

- set accelerating and non-alkaline set accelerating admixtures;
- consistence control admixtures;
- bond improving admixtures.

Provisions governing the practical application of these admixtures in the production of sprayed concrete are not part of this Standard.

Public Review draft